

Prisliste

April 2011

Hygienisk lagring

- tekniske spesifikasjoner	s 2
- mål og beregning	s 3
- reoler – aluminium	s 4
- reoler – rustfritt stål	s 6
- reoler – PP-plast	s 8
- marin utførelse	s 10
- vogner – aluminium	s 11
- vogner – rustfritt stål	s 12
- termobokser – gastronom	s 13
- termobokser – andre	s 14
- DAK - eksempel	s 14



Alminor AS

NO - 3650 Tinn Austbygd

tel +47 35 08 11 11

faks +47 35 08 11 00

mail@alminor.com

www.alminor.com

Tekniske spesifikasjoner reoler og vogner

Rustfritt stål

Reoler og vogner i rustfritt stål er fremstilt av krom/nikkelstål, kvalitet SS 2333/AISI 304. Overflaten på hyllene er mønstervalset, noe som gir høyere styrke og bedre hygieneegenskaper enn børstet overflate.

Aluminium

Reoler og vogner i aluminium er fremstilt av eloksert og lakkert aluminium som er spesielt beregnet for å tåle de kjemiske, termiske og mekaniske belastningene produktene kan få ved bruk.

Belastning og sikkerhet

Alminor System 150/250 er testet for belastning og stabilitet hos TÜV (Technische ÜberwachungsVerein) i Tyskland.

Lastekapasiteter

Jevn belastning	lengde	kapasitet
risthyller	800-1200	250 kg
	1300-1500	150 kg
platehyller	800-1200	120 kg
	1300-1500	75 kg
reolstiger	maks. belastning	1 000 kg
vogner	alle størrelser	250 kg

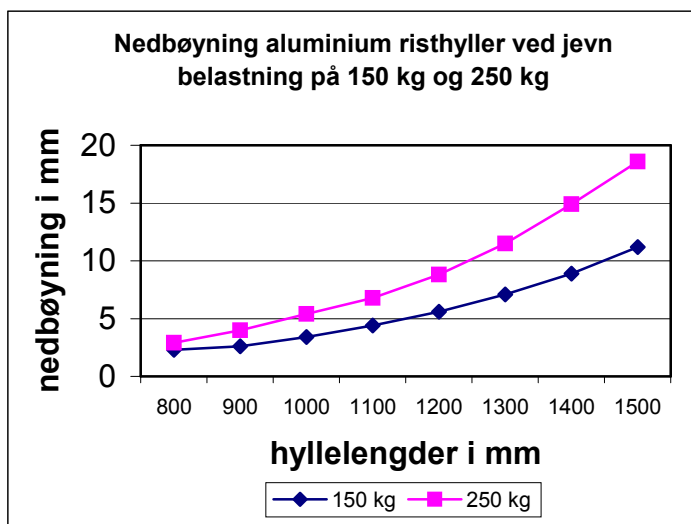

Maksimal tillatt nedbøyning er 0,5% av hyllelengden. Det vil si at en hylle på en meter skal ha maksimalt 5 mm nedbøyning.

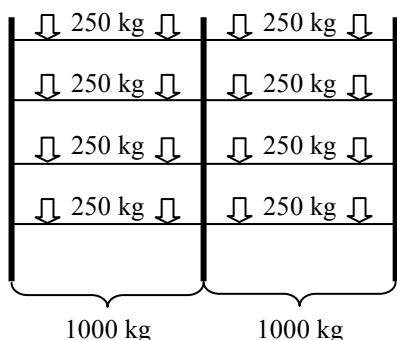

Belastningen varierer med hyllelengde og materiale, se tabellen ovenfor. Maksimal belastning for de sterkeste er uansett 250 kg, med jevn fordeling over hele hyllens flate. Maksimal last per reollengde er 1000 kg – som vist ved eksempelet til venstre.

Termobokser

Eurotherm® termobokser er produsert i plast og isolert med polyuretanskum. Den spesielle produksjonsmetoden (vakuumforming) gjør isolasjonen formstabil, slik at isolasjonsevnen beholdes gjennom hele boksens levetid. Isolasjonen inneholder ikke KFK.

Boksene tåler bruk i temperaturområdet fra -40°C til $+100^{\circ}\text{C}$ og kan vaskes i vaskemaskin. Kuldeplatene holder inntil -21°C og kjølemediet inneholder ikke KFK.

Ressursbruk

Alt avkapp i produksjonen går til gjenvinning og all emballasje vi benytter kan enten gjenbrukes eller resirkuleres.



Oppbygging

En grunnreol består av to reolstiger, hylleplan og kryss-stag. For hvert nytt reolfag trenger du en ny stige og det ønskede antall hylleplan. Plassering av kryss-stag skal være som vist på figuren nedenfor. Til tre fag trenger du kun ett kryss-stag, men ved fire til seks fag må du ha to, syv til ni fag skal ha tre osv.

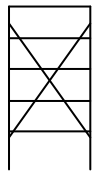

grunnreol

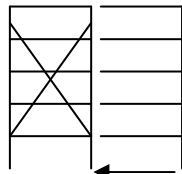

grunnreol + påbygningsreol

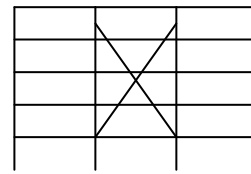

trefags reol med kryss-stag

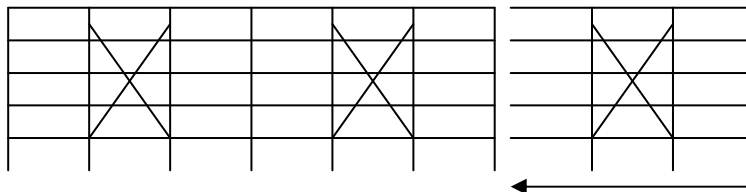

Plassberegning aluminium og rustfritt stål

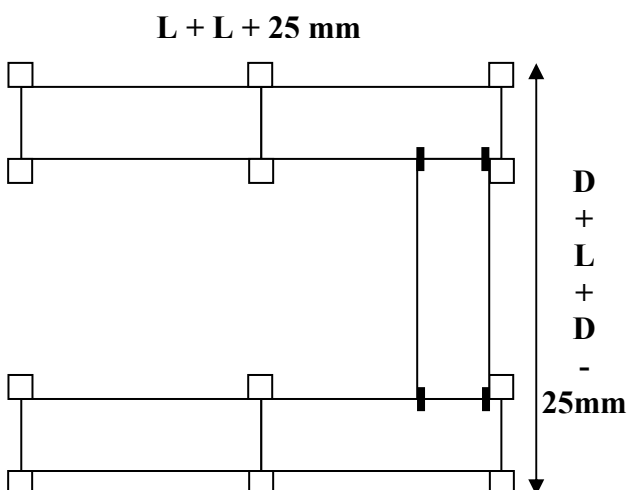
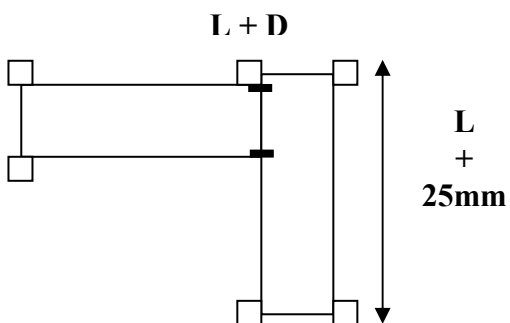
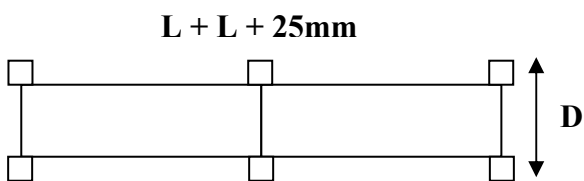

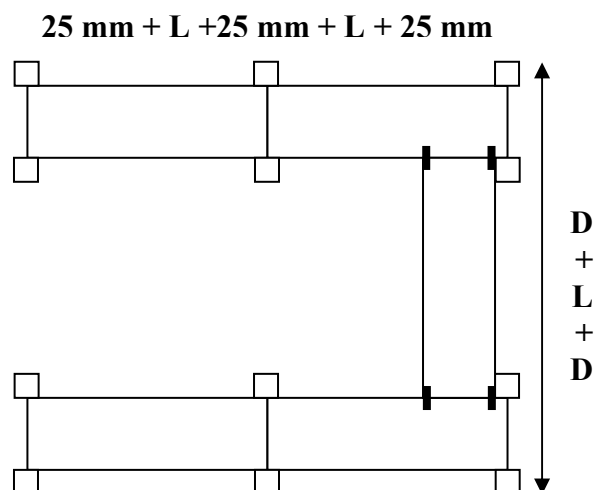
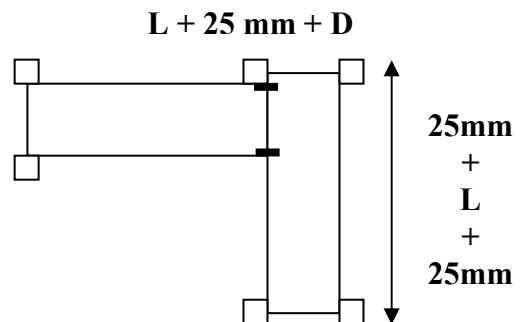
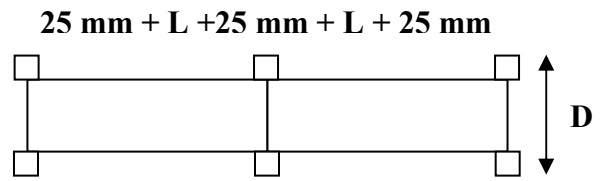

Plassberegning for PP-plastreoler



Reoler - aluminium**System 150/250**

- System 150/250 leveres også i marin utførelse for skip og offshore – se side 10

Reolstiger	Høyde	300 mm		400 mm		500 mm		600 mm	
		varenr	pris	varenr	pris	varenr	pris	varenr	pris
	1480	A130150	473	A140150	491	A150150	509	A160150	527
	1800	A130180	497	A140180	534	A150180	575	A160180	624
	2120	A130212	527	A140212	601	A150212	668	A160212	727

Risthyller	lengde	300 mm		400 mm		500 mm		600 mm	
		varenr	pris	varenr	pris	varenr	pris	varenr	pris
	800	A230080	260	A240080	317	A250080	354	A260080	386
	900	A230090	285	A240090	336	A250090	381	A260090	412
	1000	A230100	311	A240100	374	A250100	424	A260100	475
	1100	A230110	336	A240110	392	A250110	469	A260110	520
	1200	A230120	362	A240120	444	A250120	507	A260120	545
	1300	A230130	386	A240130	475	A250130	545	A260130	615
	1400	A230140	412	A240140	507	A250140	590	A260140	660
	1500	A230150	437	A240150	545	A250150	628	A260150	704

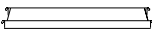
Platehyller	lengde	300 mm		400 mm		500 mm		600 mm	
		varenr	pris	varenr	pris	varenr	pris	varenr	pris
	800	A330080	260	A340080	317	A350080	354	A360080	386
	900	A330090	285	A340090	336	A350090	381	A360090	412
	1000	A330100	311	A340100	374	A350100	424	A360100	475
	1100	A330110	336	A340110	392	A350110	469	A360110	520
	1200	A330120	362	A340120	444	A350120	507	A360120	545
	1300	A330130	386	A340130	475	A350130	545	A360130	615
	1400	A330140	412	A340140	507	A350140	590	A360140	660
	1500	A330150	437	A340150	545	A350150	628	A360150	704

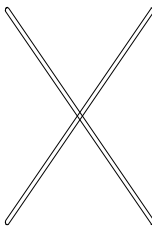
Diagonalstag	lengde	varenr	pris
	800	A4080	160
	900	A4090	160
	1000	A4100	160
	1100	A4110	160
	1200	A4120	160
	1300	A4130	160
	1400	A4140	160
	1500	A4150	160

Opphengskinne	lengde	varenr	pris
	800	A5080	220
	900	A5090	225
	1000	A5100	230
	1100	A5110	235
	1200	A5120	240
	1300	A5130	245
	1400	A5140	250
	1500	A5150	255

Hjørneklammer	varenr	pris
	4101	40

S-krok	varenr	pris
	S5001	30

Komplette reoler - aluminium**System 150/250**

- med fire hylleplan – høyde 1800 mm

Total lengde i mm	Sammen- setning	Stiger	stag	Risthyller / platehyller				Total lengde i mm
				300	400	500	600	
825	1*800	2	1	2194	2496	2726	2952	825
925	1*900	2	1	2294	2572	2834	3056	925
1025	1*1000	2	1	2398	2724	3006	3308	1025
1125	1*1100	2	1	2498	2796	3186	3488	1125
1225	1*1200	2	1	2602	3004	3338	3588	1225
1325	1*1300	2	1	2698	3128	3490	3868	1325
1425	1*1400	2	1	2802	3256	3670	4048	1425
1525	1*1500	2	1	2902	3408	3822	4224	1525
1625	2*800	3	1	3731	4298	4717	5120	1625
1725	1*800+ 1*900	3	1	3831	4374	4825	5224	1725
1825	2*900	3	1	3931	4450	4933	5328	1825
1925	1*900+ 1*1000	3	1	4035	4602	5105	5580	1925
2025	2*1000	3	1	4139	4754	5277	5832	2025
2125	1*1000+ 1*1100	3	1	4239	4826	5457	6012	2125
2225	2*1100	3	1	4339	4898	5637	6192	2225
2325	1*1100+ 1*1200	3	1	4443	5106	5789	6292	2325
2425	2*1200	3	1	4547	5314	5941	6392	2425
2525	1*1200+ 1*1300	3	1	4643	5438	6093	6672	2525
2625	2*1300	3	1	4739	5562	6245	6952	2625
2725	1*1300+ 1*1400	3	1	4843	5690	6425	7132	2725
2825	2*1400	3	1	4947	5818	6605	7312	2825
2925	1*1400+ 1*1500	3	1	5047	5970	6757	7488	2925
3025	2*1500	3	1	5147	6122	6909	7664	3025
3125	2*1000+ 1*1100	4	1	5980	6856	7728	8536	3125
3225	1*1000+ 2*1100	4	1	6080	6928	7908	8716	3225
3325	3*1100	4	1	6180	7000	8088	8896	3325
3425	2*1100+ 1*1200	4	1	6284	7208	8240	8996	3425
3525	1*1100+ 2*1200	4	1	6388	7416	8392	9096	3525
3625	3*1200	4	1	6492	7624	8544	9196	3625
3725	2*1200+ 1*1300	4	1	6588	7748	8696	9476	3725
3825	1*1200+ 2*1300	4	1	6684	7872	8848	9756	3825
3925	3*1300	4	1	6780	7996	9000	10036	3925
4025	2*1300+ 1*1400	4	1	6884	8124	9180	10216	4025
4125	1*1300+ 2*1400	4	1	6988	8252	9360	10396	4125
4225	3*1400	4	1	7092	8380	9540	10576	4225
4325	2*1400+ 1*1500	4	1	7192	8532	9692	10752	4325
4425	1*1400+ 2*1500	4	1	7292	8684	9844	10928	4425
4525	3*1500	4	1	7392	8836	9996	11104	4525
4625	2*1100+ 2*1200	5	2	8389	9678	11003	11960	4625
4725	1*1100+ 3*1200	5	2	8493	9886	11155	12060	4725
4825	4*1200	5	2	8597	10094	11307	12160	4825
4925	3*1200+ 1*1300	5	2	8693	10218	11459	12440	4925
5025	2*1200+ 2*1300	5	2	8789	10342	11611	12720	5025
5125	1*1200+ 3*1300	5	2	8885	10466	11763	13000	5125
5225	4*1300	5	2	8981	10590	11915	13280	5225
5325	3*1300+ 1*1400	5	2	9085	10718	12095	13460	5325
5425	2*1300+ 2*1400	5	2	9189	10846	12275	13640	5425
5525	1*1300+ 3*1400	5	2	9293	10974	12455	13820	5525
5625	4*1400	5	2	9397	11102	12635	14000	5625
5725	3*1400+ 1*1500	5	2	9497	11254	12787	14176	5725
5825	2*1400+ 2*1500	5	2	9597	11406	12939	14352	5825
5925	1*1400+ 3*1500	5	2	9697	11558	13091	14528	5925
6025	4*1500	5	2	9797	11710	13243	14704	6025

Reoler - rustfritt stål**System 150/250**

- System 150/250 leveres også i marin utførelse for skip og offshore – se side 10

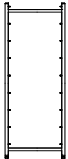
Reolstiger	Høyde	300 mm		400 mm		500 mm		600 mm	
		varenr	pris	varenr	pris	varenr	pris	varenr	pris
	1480	S130150	886	S140150	912	S150150	978	S160150	1042
	1800	S130180	951	S140180	978	S150180	1042	S160180	1109
	2120	S130212	1015	S140212	1042	S150212	1109	S160212	1173

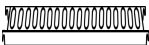
Risthyller	lengde	300 mm		400 mm		500 mm		600 mm	
		varenr	pris	varenr	pris	varenr	pris	varenr	pris
	800	S230080	495	S240080	547	S250080	633	S260080	704
	900	S230090	547	S240090	599	S250090	670	S260090	743
	1000	S230100	599	S240100	658	S250100	718	S260100	788
	1100	S230110	679	S240110	736	S250110	782	S260110	834
	1200	S230120	743	S240120	808	S250120	840	S260120	894
	1300	S230130	808	S240130	867	S250130	894	S260130	925
	1400	S230140	848	S240140	906	S250140	951	S260140	997
	1500	S230150	899	S240150	951	S250150	1010	S260150	1049

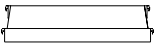
Platehyller	lengde	300 mm		400 mm		500 mm		600 mm	
		varenr	pris	varenr	pris	varenr	pris	varenr	pris
	800	S330080	443	S340080	495	S350080	572	S360080	639
	900	S330090	495	S340090	547	S350090	612	S360090	679
	1000	S330100	547	S340100	599	S350100	652	S360100	718
	1100	S330110	612	S340110	670	S350110	710	S360110	762
	1200	S330120	679	S340120	736	S350120	762	S360120	800
	1300	S330130	730	S340130	788	S350130	814	S360130	854
	1400	S330140	769	S340140	827	S350140	867	S360140	906
	1500	S330150	808	S340150	867	S350150	919	S360150	958

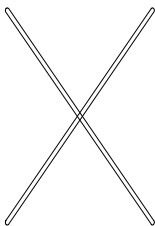
Diagonalstag	lengde	varenr	pris
	800	S4080	200
	900	S4090	200
	1000	S4100	200
	1100	S4110	200
	1200	S4120	200
	1300	S4130	200
	1400	S4140	200
1500	S4150	200	

Ressursbruk

Alt avkapp i produksjonen går til gjenvinning og all emballasje vi benytter kan enten gjenbrukes eller resirkuleres.



Hjørneklammer	varenr	pris
	4101	40

S-krok	varenr	pris
	S5001	30

Komplette reoler - rustfritt stål**System 150/250**

- med fire hylleplan – høyde 1800 mm

Lengde i mm	Sammen- setning	Stiger	Stag	Risthyller				Platehyller			
				300	400	500	600	300	400	500	600
825	1*800	2	1	4082	4344	4816	5234	3874	4136	4572	4974
925	1*900	2	1	4290	4552	4964	5390	4082	4344	4732	5134
1025	1*1000	2	1	4498	4788	5156	5570	4290	4552	4892	5290
1125	1*1100	2	1	4818	5100	5412	5754	4550	4836	5124	5466
1225	1*1200	2	1	5074	5388	5644	5994	4818	5100	5332	5618
1325	1*1300	2	1	5334	5624	5860	6118	5022	5308	5540	5834
1425	1*1400	2	1	5494	5780	6088	6406	5178	5464	5752	6042
1525	1*1500	2	1	5698	5960	6124	6614	5334	5624	5960	6250
1625	2*800	3	1	7013	7510	8390	9159	6597	7094	7902	8639
1725	1*800+ 1*900	3	1	7221	7718	8538	9315	6805	7302	8062	8799
1825	2*900	3	1	7429	7926	8686	9471	7013	7510	8222	8959
1925	1*900+ 1*1000	3	1	7637	8162	8878	9651	7221	7718	8382	9115
2025	2*1000	3	1	7845	8398	9070	9831	7429	7926	8542	9271
2125	1*1000+ 1*1100	3	1	8165	8710	9326	10015	7689	8210	8774	9447
2225	2*1100	3	1	8485	9022	9582	10199	7949	8494	9006	9623
2325	1*1100+ 1*1200	3	1	8741	9310	9814	10439	8217	8758	9214	9775
2425	2*1200	3	1	8997	9598	10046	10679	8485	9022	9422	9927
2525	1*1200+ 1*1300	3	1	9257	9834	10262	10803	8689	9230	9630	10143
2625	2*1300	3	1	9517	10070	10478	10927	8893	9438	9838	10359
2725	1*1300+ 1*1400	3	1	9677	10226	10706	11215	9049	9594	10050	10567
2825	2*1400	3	1	9837	10382	10934	11503	9205	9750	10262	10775
2925	1*1400+ 1*1500	3	1	10041	10562	11170	11711	9361	9910	10470	10983
3025	2*1500	3	1	10245	10742	11406	11919	9517	10070	10678	11191
3125	2*1000+ 1*1100	4	1	11512	12320	13240	14276	10828	11584	12424	13428
3225	1*1000+ 2*1100	4	1	11832	12632	13496	14460	11088	11868	12656	13604
3325	3*1100	4	1	12152	12944	13752	14644	11348	12152	12888	13780
3425	2*1100+ 1*1200	4	1	12408	13232	13984	14884	11616	12416	13096	13932
3525	1*1100+ 2*1200	4	1	12664	13520	14216	15124	11884	12680	13304	14084
3625	3*1200	4	1	12920	13808	14448	15364	12152	12944	13512	14236
3725	2*1200+ 1*1300	4	1	13180	14044	14664	15488	12356	13152	13720	14452
3825	1*1200+ 2*1300	4	1	13440	14280	14880	15612	12560	13360	13928	14668
3925	3*1300	4	1	13700	14516	15096	15736	12764	13568	14136	14884
4025	2*1300+ 1*1400	4	1	13860	14672	15324	16024	12920	13724	14348	15092
4125	1*1300+ 2*1400	4	1	14020	14828	15552	16312	13076	13880	14560	15300
4225	3*1400	4	1	14180	14984	15780	16600	13232	14036	14772	15508
4325	2*1400+ 1*1500	4	1	14384	15164	16016	16808	13388	14196	14980	15716
4425	1*1400+ 2*1500	4	1	14588	15344	16252	17016	13544	14356	15188	15924
4525	3*1500	4	1	14792	15524	16488	17224	13700	14516	15396	16132
4625	2*1100+ 2*1200	5	2	16531	17642	18586	19769	15483	16538	17386	18441
4725	1*1100+ 3*1200	5	2	16787	17930	18818	20009	15751	16802	17594	18593
4825	4*1200	5	2	17043	18218	19050	20249	16019	17066	17802	18745
4925	3*1200+ 1*1300	5	2	17303	18454	19266	20373	16223	17274	18010	18961
5025	2*1200+ 2*1300	5	2	17563	18690	19482	20497	16427	17482	18218	19177
5125	1*1200+ 3*1300	5	2	17823	18926	19698	20621	16631	17690	18426	19393
5225	4*1300	5	2	18083	19162	19914	20745	16835	17898	18634	19609
5325	3*1300+ 1*1400	5	2	18243	19318	20142	21033	16991	18054	18846	19817
5425	2*1300+ 2*1400	5	2	18403	19474	20370	21321	17147	18210	19058	20025
5525	1*1300+ 3*1400	5	2	18563	19630	20598	21609	17303	18366	19270	20233
5625	4*1400	5	2	18723	19786	20826	21897	17459	18522	19482	20441
5725	3*1400+ 1*1500	5	2	18927	19966	21062	22105	17615	18682	19690	20649
5825	2*1400+ 2*1500	5	2	19131	20146	21298	22313	17771	18842	19898	20857
5925	1*1400+ 3*1500	5	2	19335	20326	21534	22521	17927	19002	20106	21065
6025	4*1500	5	2	19539	20506	21770	22729	18083	19162	20314	21273

Reoler – PP-plast/aluminium**System 150/250**

- System 150/250 leveres også i marin utførelse for skip og offshore – se side 10

Reolstiger	Høyde	300 mm		400 mm		500 mm		600 mm	
		varenr	pris	varenr	pris	varenr	pris	varenr	pris
	1480	A130150	473	A140150	491	A150150	509	A160150	527
	1800	A130180	497	A140180	534	A150180	575	A160180	624
	2120	A130212	527	A140212	601	A150212	668	A160212	727

PP-rist	lengde	300 mm		400 mm		500 mm		600 mm	
		varenr	pris	varenr	pris	varenr	pris	varenr	pris
	300	P230030	76	P240030	83	P250030	91	P260030	101
	400	P230040	87	P240040	97	P250040	109	P260040	120

PP-plate	lengde	300 mm		400 mm		500 mm		600 mm	
		varenr	pris	varenr	pris	varenr	pris	varenr	pris
	300	P330030	82	P340030	88	P350030	97	P360030	108
	400	P330040	91	P340040	103	P350040	114	P360040	126

Hyllevanger	lengde	varenr	pris
Du trenger to vanger pr. hylleplan.	600	P6060	55
	700	P6070	62
	800	P6080	69
	900	P6090	76
	1000	P6100	81
	1100	P6110	86
Prisen er oppgitt pr. stk.	1200	P6120	94
	1300	P6130	101
	1400	P6140	107
	1500	P6150	112

Hjørneklammer	varenr	pris
	P4101	40

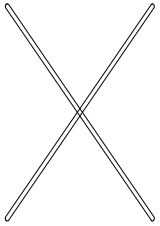
Diagonalstag	lengde	varenr	pris
	800	P4080	160
	900	P4090	160
	1000	P4100	160
	1100	P4110	160
	1200	P4120	160
	1300	P4130	160
	1400	P4140	160
	1500	P4150	160

Komplette reoler – PP-plast/aluminium System 150/250

- med fire hylleplan – høyde 1800 mm – uttakbare paneler som kan vaskes i oppvaskmaskin

Lengde i mm	Antall paneler		Stiger	Stag	Risthyller				Platehyller			
	300	400			300	400	500	600	300	400	500	600
650	8		2	1	2202	2332	2478	2656	2250	2372	2526	2712
750	4	4	2	1	2302	2444	2606	2788	2342	2488	2650	2840
850		8	2	1	2402	2556	2734	2920	2434	2604	2774	2968
950	12		2	1	2674	2832	3010	3228	2746	2892	3082	3312
1050	8	4	2	1	2758	2928	3122	3344	2822	2992	3190	3424
1150	4	8	2	1	2842	3024	3234	3460	2898	3092	3298	3536
1250		12	2	1	2950	3144	3370	3600	2998	3216	3430	3672
1350	12	4	2	1	3222	3420	3646	3908	3310	3504	3738	4016
1450	8	8	2	1	3314	3524	3766	4032	3394	3612	3854	4136
1550	4	12	2	1	3398	3620	3878	4148	3470	3712	3962	4248
1675		16	3	1	4147	4418	4733	5056	4211	4514	4813	5152
1775	12	8	3	1	4419	4694	5009	5364	4523	4802	5121	5496
1875	24		3	1	4691	4970	5285	5672	4835	5090	5429	5840
1975	20	4	3	1	4775	5066	5397	5788	4911	5190	5537	5952
2075	16	8	3	1	4859	5162	5509	5904	4987	5290	5645	6064
2175	12	12	3	1	4943	5258	5621	6020	5063	5390	5753	6176
2275	8	16	3	1	5027	5354	5733	6136	5139	5490	5861	6288
2375	4	20	3	1	5135	5474	5869	6276	5239	5614	5993	6424
2475		24	3	1	5243	5594	6005	6416	5339	5738	6125	6560
2575	12	16	3	1	5515	5870	6281	6724	5651	6026	6433	6904
2675	24	8	3	1	5787	6146	6557	7032	5963	6314	6741	7248
2775	20	12	3	1	5879	6250	6677	7156	6047	6422	6857	7368
2875	16	16	3	1	5971	6354	6797	7280	6131	6530	6973	7488
2975	12	20	3	1	6055	6450	6909	7396	6207	6630	7081	7600
3075	8	24	3	1	6139	6546	7021	7512	6283	6730	7189	7712
3200	20	16	4	1	7044	7492	8008	8580	7228	7688	8208	8816
3300	16	20	4	1	7128	7588	8120	8696	7304	7788	8316	8928
3400	12	24	4	1	7212	7684	8232	8812	7380	7888	8424	9040
3500	8	28	4	1	7320	7804	8368	8952	7480	8012	8556	9176
3600	4	32	4	1	7428	7924	8504	9092	7580	8136	8688	9312
3700		36	4	1	7536	8044	8640	9232	7680	8260	8820	9448
3800	12	28	4	1	7808	8320	8916	9540	7992	8548	9128	9792
3900	24	20	4	1	8080	8596	9192	9848	8304	8836	9436	10136
4000	36	12	4	1	8352	8872	9468	10156	8616	9124	9744	10480
4100	32	16	4	1	8444	8976	9588	10280	8700	9232	9860	10600
4200	28	20	4	1	8536	9080	9708	10404	8784	9340	9976	10720
4300	24	24	4	1	8628	9184	9828	10528	8868	9448	10092	10840
4400	20	28	4	1	8712	9280	9940	10644	8944	9548	10200	10952
4500	16	32	4	1	8796	9376	10052	10760	9020	9648	10308	11064
4600	12	36	4	1	8880	9472	10164	10876	9096	9748	10416	11176
4725	8	40	5	2	9773	10414	11163	11928	9981	10694	11411	12224
4825	4	44	5	2	9881	10534	11299	12068	10081	10818	11543	12360
4925		48	5	2	9989	10654	11435	12208	10181	10942	11675	12496
5025	12	40	5	2	10261	10930	11711	12516	10493	11230	11983	12840
5125	24	32	5	2	10533	11206	11987	12824	10805	11518	12291	13184
5225	36	24	5	2	10805	11482	12263	13132	11117	11806	12599	13528
5325	48	16	5	2	11077	11758	12539	13440	11429	12094	12907	13872
5425	44	20	5	2	11169	11862	12659	13564	11513	12202	13023	13992
5525	40	24	5	2	11261	11966	12779	13688	11597	12310	13139	14112
5625	36	28	5	2	11353	12070	12899	13812	11681	12418	13255	14232
5725	32	32	5	2	11445	12174	13019	13936	11765	12526	13371	14352
5825	28	36	5	2	11529	12270	13131	14052	11841	12626	13479	14464
5925	24	40	5	2	11613	12366	13243	14168	11917	12726	13587	14576
6025	20	44	5	2	11697	12462	13355	14284	11993	12826	13695	14688

Tilpassing for marin utførelse

System 150/250

lengde	Slingrekant Rustfritt stål		Slingrekant Aluminium	
	varenr	pris	varenr	pris
800	S550080	185	A550080	155
900	S550090	185	A550090	155
1000	S550100	200	A550100	165
1100	S550110	200	A550110	165
1200	S550120	210	A550120	175
1300	S550130	210	A550130	175
1400	S550140	220	A550140	185
1500	S550150	220	A550150	185

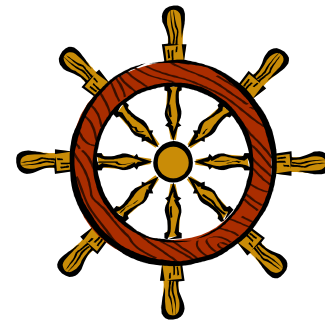

dybde	Slingrekanter ende	
	varenr	pris
300	S550030	310
300	S550040	330
500	S550050	350
600	S550060	370

Dørkfester	varenr	pris
		54

Tak/dørkfester	varenr	pris
		55

Veggklammer	varenr	pris
		S54

Tillegg omvendt hylle	varenr	pris
		O55

Her finnes utstyr som gjør at du kan benytte våre standardreoler for skip, offshore og transportmidler.

Vi produserer også etter mål.

Vogner - aluminium**System 150/250**

- System 150/250 leveres også i marin utførelse for skip og offshore – se side 10

Høyde 1480 mm		Prisene inkluderer to reolstiger, fire avstivere, fire hjul med sving hvorav to er låsbare. For hyller til vognene, se prislister for dette.						
lengde	d = 300 mm		d = 400 mm		d = 500 mm		d = 600 mm	
	varenr	pris	varenr	pris	varenr	pris	varenr	pris
800	A730080150	3 590	A740080150	3 640	A750080150	3 690	A760080150	3 730
900	A730090150		A740090150		A750090150		A760090150	
1000	A730100150		A740100150		A750100150		A760100150	
1100	A730110150		A740110150		A750110150		A760110150	
1200	A730120150		A740120150		A750120150		A760120150	
1300	A730130150		A740130150		A750130150		A760130150	
1400	A730140150		A740140150		A750140150		A760140150	
1500	A730150150		A740150150		A750150150		A760150150	

Høyde 1800 mm		Prisene inkluderer to reolstiger, fire avstivere, fire hjul med sving hvorav to er låsbare. For hyller til vognene, se prislister for dette.						
lengde	d = 300 mm		d = 400 mm		d = 500 mm		d = 600 mm	
	varenr	pris	varenr	pris	varenr	pris	varenr	pris
800	A730080180	3 640	A740080180	3 710	A750080180	3 790	A760080180	3 920
900	A730090180		A740090180		A750090180		A760090180	
1000	A730100180		A740100180		A750100180		A760100180	
1100	A730110180		A740110180		A750110180		A760110180	
1200	A730120180		A740120180		A750120180		A760120180	
1300	A730130180		A740130180		A750130180		A760130180	
1400	A730140180		A740140180		A750140180		A760140180	
1500	A730150180		A740150180		A750150180		A760150180	

Høyde 2120 mm		Prisene inkluderer to reolstiger, fire avstivere, fire hjul med sving hvorav to er låsbare. For hyller til vognene, se prislister for dette.						
lengde	d = 300 mm		d = 400 mm		d = 500 mm		d = 600 mm	
	Varenr	pris	varenr	pris	varenr	pris	varenr	pris
800	A730080212	3 860	A740080212	3 920	A750080212	4 050	A760080212	4 180
900	A730090212		A740090212		A750090212		A760090212	
1000	A730100212		A740100212		A750100212		A760100212	
1100	A730110212		A740110212		A750110212		A760110212	
1200	A730120212		A740120212		A750120212		A760120212	
1300	A730130212		A740130212		A750130212		A760130212	
1400	A730140212		A740140212		A750140212		A760140212	
1500	A730150212		A740150212		A750150212		A760150212	

Vogner – rustfritt stål**System 150/250**



- System 150/250 leveres også i marin utførelse for skip og offshore – se side 10

Høyde 1480 mm		Prisene inkluderer to reolstiger, fire avstivere, fire hjul med sving hvorav to er låsbare. For hyller til vognene, se prisliste for dette.							
lengde	d = 300 mm		d = 400 mm		d = 500 mm		d = 600 mm		
	varenr	pris	varenr	pris	varenr	pris	varenr	pris	
800	S730080150	5 591	S740080150	5 655	S750080150	5 788	S760080150	5 920	
900	S730090150	5 642	S740090150	5 712	S750090150	5 839	S760090150	5 971	
1000	S730100150	5 693	S740100150	5 763	S750100150	5 895	S760100150	6 028	
1100	S730110150	5 750	S740110150	5 813	S750110150	5 946	S760110150	6 079	
1200	S730120150	5 801	S740120150	5 864	S750120150	5 996	S760120150	6 130	
1300	S730130150	5 857	S740130150	5 920	S750130150	6 054	S760130150	6 180	
1400	S730140150	5 908	S740140150	5 971	S750140150	6 104	S760140150	6 236	
1500	S730150150	5 958	S740150150	6 028	S750150150	6 155	S760150150	6 287	

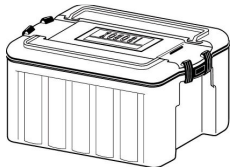
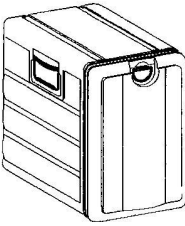

Høyde 1800 mm		Prisene inkluderer to reolstiger, fire avstivere, fire hjul med sving hvorav to er låsbare. For hyller til vognene, se prisliste for dette.							
lengde	d = 300 mm		d = 400 mm		d = 500 mm		d = 600 mm		
	varenr	pris	varenr	pris	varenr	pris	varenr	pris	
800	S730080180	5 725	S740080180	5 788	S750080180	5 920	S760080180	6 054	
900	S730090180	5 775	S740090180	5 839	S750090180	5 971	S760090180	6 104	
1000	S730100180	5 826	S740100180	5 895	S750100180	6 028	S760100180	6 155	
1100	S730110180	5 882	S740110180	5 947	S750110180	6 079	S760110180	6 211	
1200	S730120180	5 933	S740120180	5 996	S750120180	6 130	S760120180	6 262	
1300	S730130180	5 983	S740130180	6 054	S750130180	6 186	S760130180	6 312	
1400	S730140180	6 041	S740140180	6 104	S750140180	6 236	S760140180	6 370	
1500	S730150180	6 092	S740150180	6 161	S750150180	6 287	S760150180	6 420	

Høyde 2120 mm		Prisene inkluderer to reolstiger, fire avstivere, fire hjul med sving hvorav to er låsbare. For hyller til vognene, se prisliste for dette.							
lengde	d = 300 mm		d = 400 mm		d = 500 mm		d = 600 mm		
	Varenr	pris	varenr	pris	varenr	pris	varenr	pris	
800	S730080212	5 895	S740080212	5 958	S750080212	6 097	S760080212	6 236	
900	S730090212	5 946	S740090212	6 016	S750090212	6 148	S760090212	6 287	
1000	S730100212	6 003	S740100212	6 072	S750100212	6 211	S760100212	6 338	
1100	S730110212	6 059	S740110212	6 123	S750110212	6 262	S760110212	6 395	
1200	S730120212	6 110	S740120212	6 173	S750120212	6 312	S760120212	6 452	
1300	S730130212	6 161	S740130212	6 236	S750130212	6 370	S760130212	6 502	
1400	S730140212	6 224	S740140212	6 287	S750140212	6 426	S760140212	6 560	
1500	S730150212	6 274	S740150212	6 345	S750150212	6 477	S760150212	6 610	

Termobokser – plast – Gastronom

Eurotherm®	Type	Kapasitet / utstyr	Pris	Dimensjon i mm			Vekt kg
				L	B	H	
	E200	1 stk GN 1/1 – 100 mm	2 480	680	415	238	6,2
	E300	1 GN 1/1 – 200 mm	2 930	680	415	338	7,5
	E600	4 GN 1/1 – 100 mm Bærehåndtak	4 800	660	465	652	14,0
	E600R	4 GN 1/1 – 100 mm Bærehåndtak og hjul	7 100	660	465	790	18,5
	Kjøleplate	- 21° C til E600	616	530	320	31	4,1

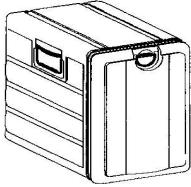
Termobokser – plast – andre størrelser

Eurotherm® Croissant	Type	Kapasitet / utstyr	Pris	Dimensjon i mm			Vekt
				L	B	H	
	E1100	8 eller 11 brett Bærehåndtak	8 500	725	560	730	20,0
	E1100R	8 eller 11 brett Bærehåndtak og hjul	11 060	725	560	863	25,5
	Kjøleplate	- 21° C til E1100	830				6,1

DAK-system

Send oss en skisse eller romtegninger så tegner vi inn og beregner behovet ditt i vårt DAK-system. Nedenfor ser du eksempel på hvordan dette kan se ut, både to- og tredimensjonalt

